

HARRING DOORS HAS A LARGE LIBRARY OF CUSTOM TOOLING AVAILABLE. THESE DRAWINGS ILLUSTRATE OUR MOST COMMON PROFILES. WE CAN ALSO SOURCE CUSTOM TOOLING TO ACCOMMODATE YOUR CUSTOM DOOR REQUIREMENTS. CONTACT OUR SALES DEPARTMENT WITH ANY CUSTOM REQUESTS

STANDARD PROFILES (EXTERIOR DOORS)

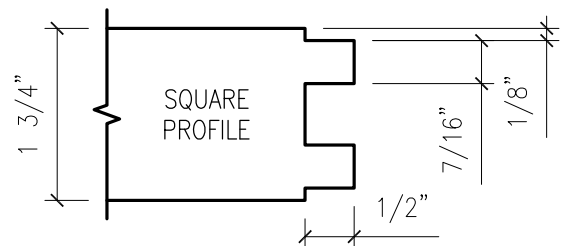
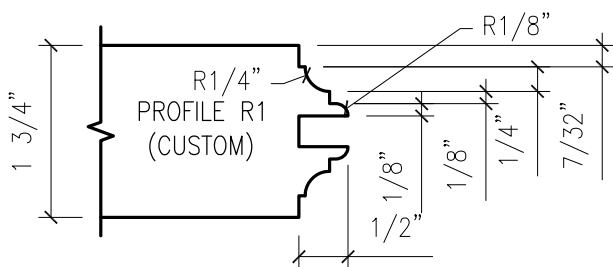
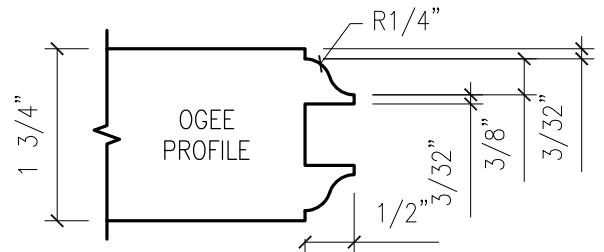
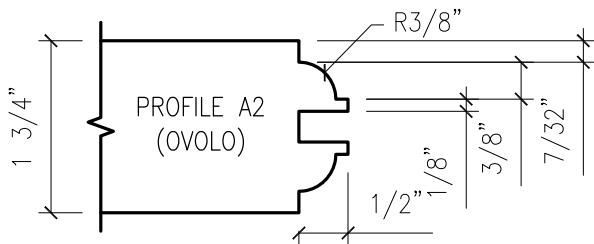
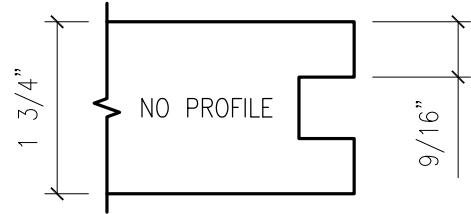
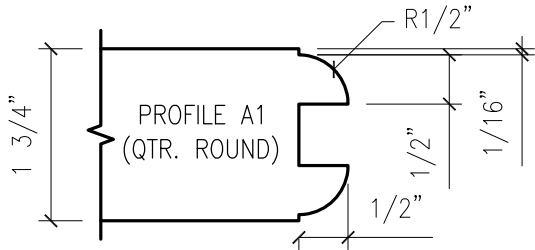

HARRING DOORS HAS A LARGE LIBRARY OF CUSTOM TOOLING AVAILABLE. THESE DRAWINGS ILLUSTRATE OUR MOST COMMON PROFILES. WE CAN ALSO SOURCE CUSTOM TOOLING TO ACCOMMODATE YOUR CUSTOM DOOR REQUIREMENTS. CONTACT OUR SALES DEPARTMENT WITH ANY CUSTOM REQUESTS

STANDARD EXTERIOR PANELS

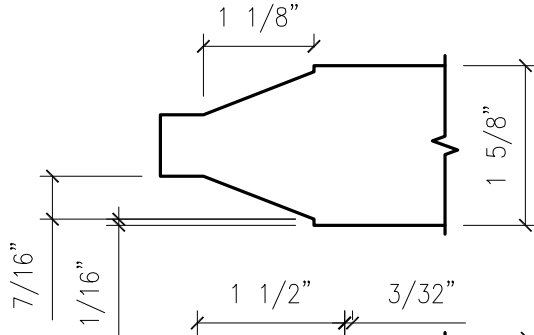

PANEL A1
(RIM BANDED)

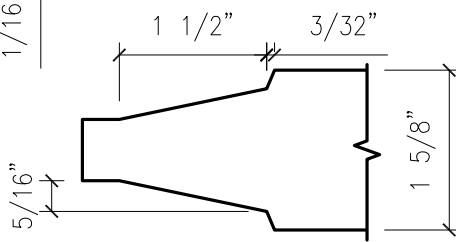

PANEL 3
(RIM BANDED)

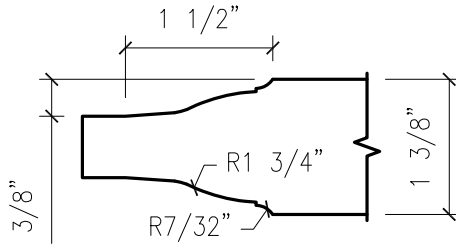

PANEL R1
(RIM BANDED)

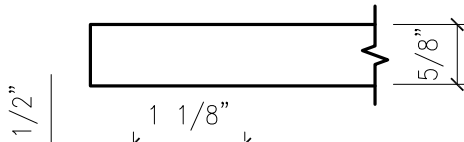

FLAT PANEL



PANEL 2
(RIM BANDED OR
FORMED VENEER)

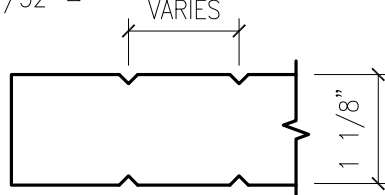

V-GROOVE FLAT PANEL

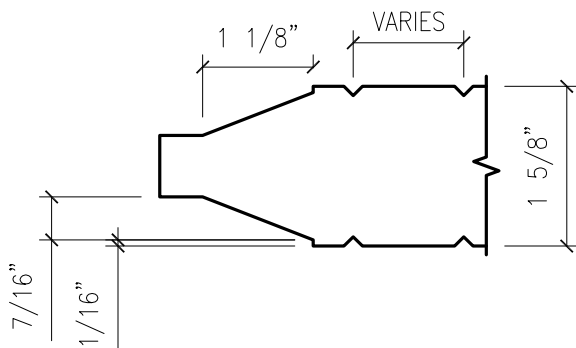

V-GROOVE RAISED PANEL
(RIM BANDED)

HARRING DOORS HAS A LARGE LIBRARY OF CUSTOM TOOLING AVAILABLE. THESE DRAWINGS ILLUSTRATE OUR MOST COMMON PROFILES. WE CAN ALSO SOURCE CUSTOM TOOLING TO ACCOMMODATE YOUR CUSTOM DOOR REQUIREMENTS. CONTACT OUR SALES DEPARTMENT WITH ANY CUSTOM REQUESTS

STANDARD A1 (QTR ROUND) PROFILE WITH STANDARD PANELS

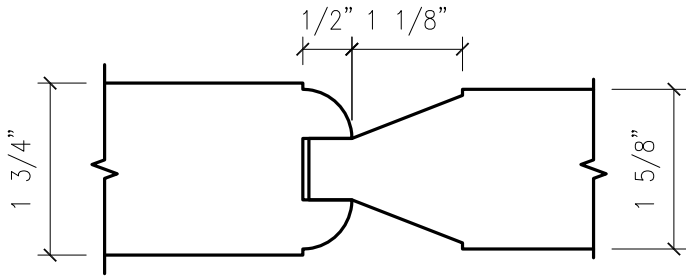

PANEL A1
(RIM BANDED)

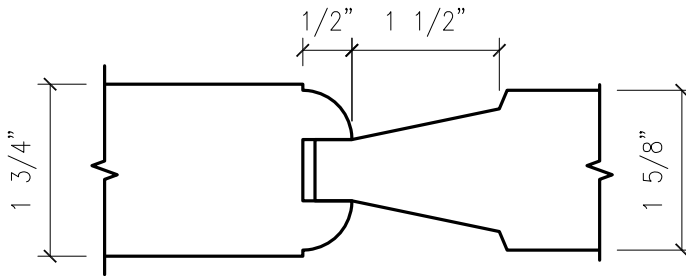

PANEL 3
(RIM BANDED)

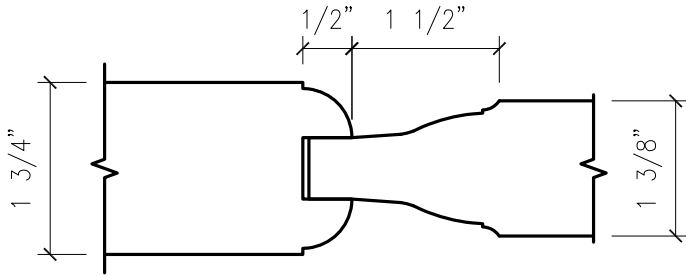

PANEL R1
(RIM BANDED)

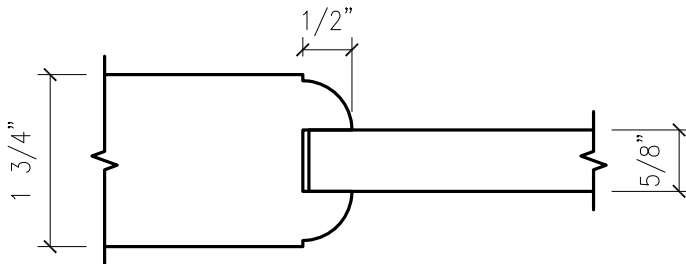

FLAT PANEL

HARRING DOORS HAS A LARGE LIBRARY OF CUSTOM TOOLING AVAILABLE. THESE DRAWINGS ILLUSTRATE OUR MOST COMMON PROFILES. WE CAN ALSO SOURCE CUSTOM TOOLING TO ACCOMMODATE YOUR CUSTOM DOOR REQUIREMENTS. CONTACT OUR SALES DEPARTMENT WITH ANY CUSTOM REQUESTS

STANDARD A1 (QTR ROUND) PROFILE WITH STANDARD PANELS

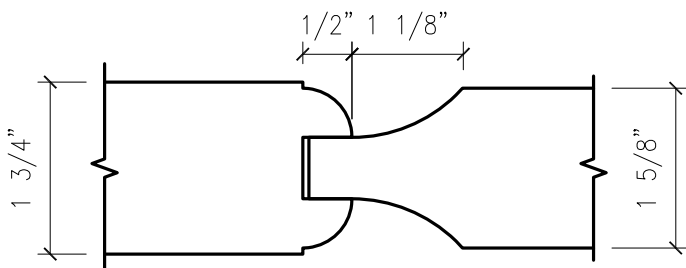

PANEL 2
(RIM BANDED OR
FORMED VENEER)

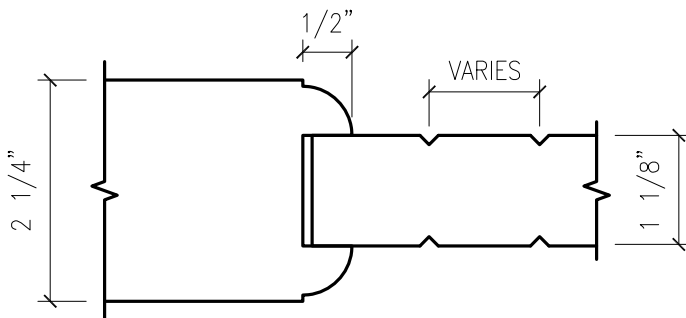

V-GROOVE FLATPANEL
(NOT AVAILABLE WITH 1 3/4" DOOR THICKNESS)

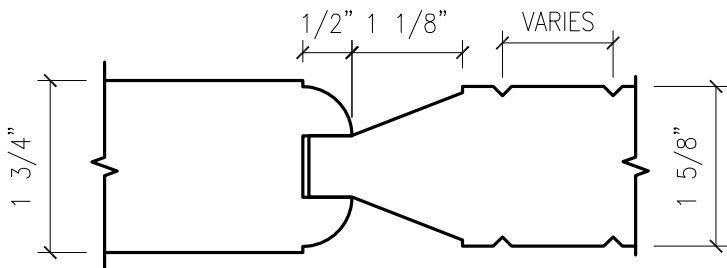

V-GROOVE RAISED PANEL

HARRING DOORS HAS A LARGE LIBRARY OF CUSTOM TOOLING AVAILABLE. THESE DRAWINGS ILLUSTRATE OUR MOST COMMON PROFILES. WE CAN ALSO SOURCE CUSTOM TOOLING TO ACCOMMODATE YOUR CUSTOM DOOR REQUIREMENTS. CONTACT OUR SALES DEPARTMENT WITH ANY CUSTOM REQUESTS

STANDARD A2 (OVOLO) PROFILE WITH STANDARD PANELS

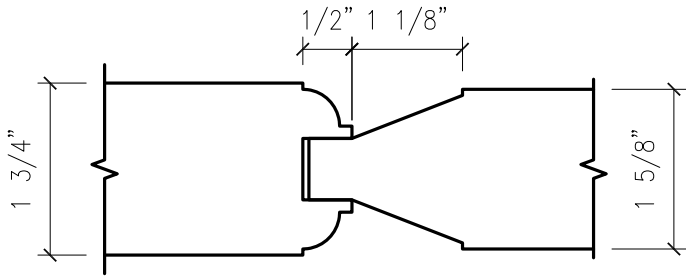

PANEL A1
(RIM BANDED)

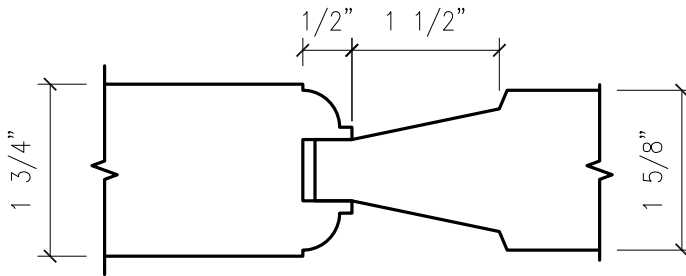

PANEL 3
(RIM BANDED)

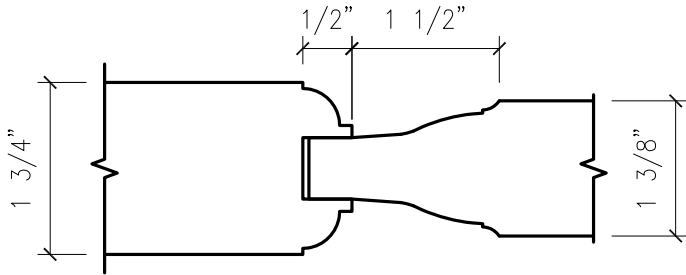

PANEL R1
(RIM BANDED)

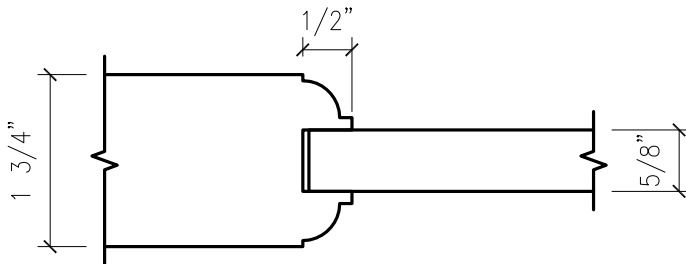

FLAT PANEL

HARRING DOORS HAS A LARGE LIBRARY OF CUSTOM TOOLING AVAILABLE. THESE DRAWINGS ILLUSTRATE OUR MOST COMMON PROFILES. WE CAN ALSO SOURCE CUSTOM TOOLING TO ACCOMMODATE YOUR CUSTOM DOOR REQUIREMENTS. CONTACT OUR SALES DEPARTMENT WITH ANY CUSTOM REQUESTS

STANDARD A2 (OVOLO) PROFILE WITH STANDARD PANELS

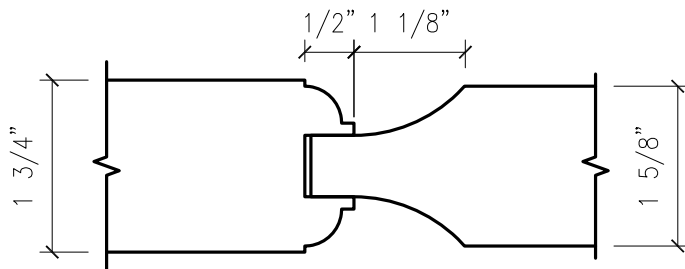

PANEL 2
(RIM BANDED OR
FORMED VENEER)

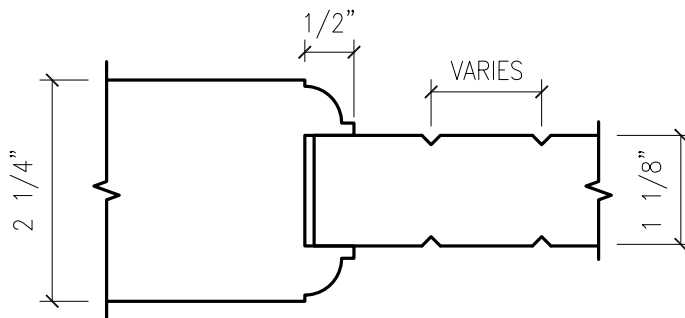

V-GROOVE FLATPANEL
(NOT AVAILABLE WITH 1 3/4\"/>

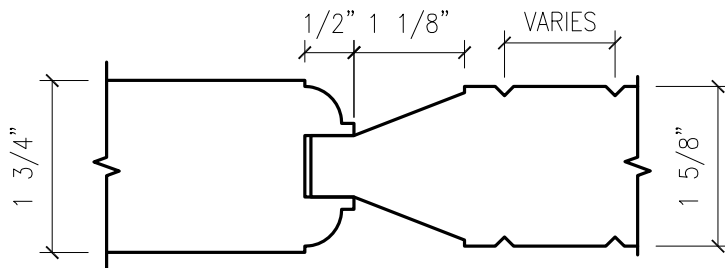

V-GROOVE RAISED PANEL

HARRING DOORS HAS A LARGE LIBRARY OF CUSTOM TOOLING AVAILABLE. THESE DRAWINGS ILLUSTRATE OUR MOST COMMON PROFILES. WE CAN ALSO SOURCE CUSTOM TOOLING TO ACCOMMODATE YOUR CUSTOM DOOR REQUIREMENTS. CONTACT OUR SALES DEPARTMENT WITH ANY CUSTOM REQUESTS

STANDARD R1 (CUSTOM) PROFILE WITH STANDARD PANELS

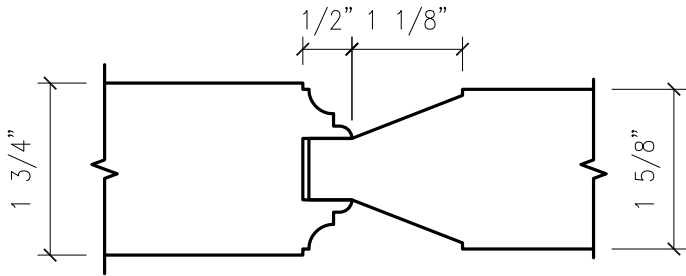

PANEL A1
(RIM BANDED)

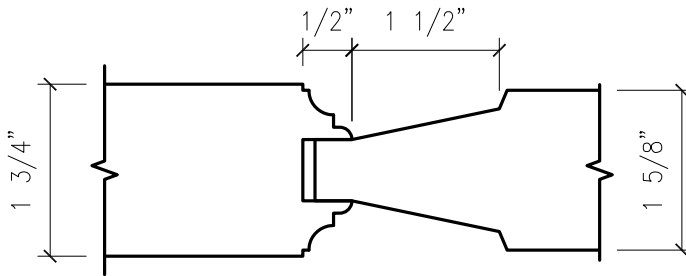

PANEL 3
(RIM BANDED)

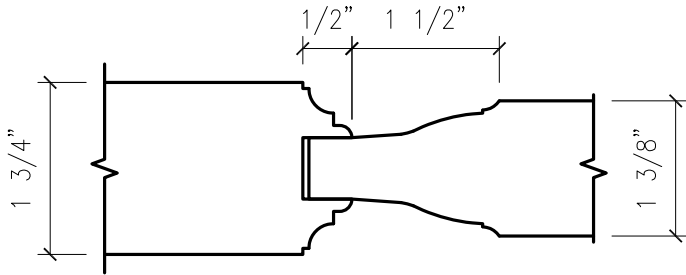

PANEL R1
(RIM BANDED)

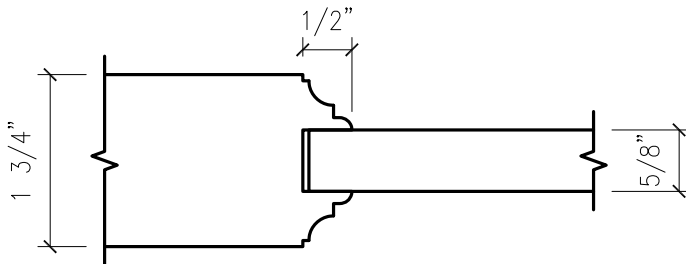

FLAT PANEL

HARRING DOORS HAS A LARGE LIBRARY OF CUSTOM TOOLING AVAILABLE. THESE DRAWINGS ILLUSTRATE OUR MOST COMMON PROFILES. WE CAN ALSO SOURCE CUSTOM TOOLING TO ACCOMMODATE YOUR CUSTOM DOOR REQUIREMENTS. CONTACT OUR SALES DEPARTMENT WITH ANY CUSTOM REQUESTS

STANDARD R1 (CUSTOM) PROFILE WITH STANDARD PANELS

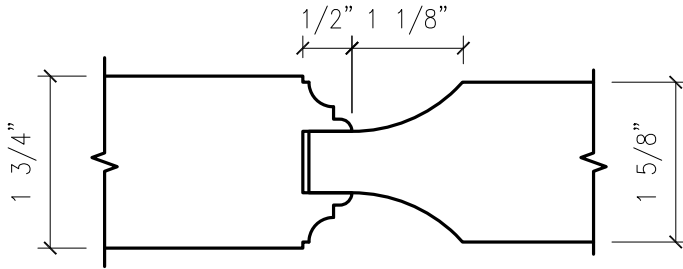

PANEL 2
(RIM BANDED OR
FORMED VENEER)

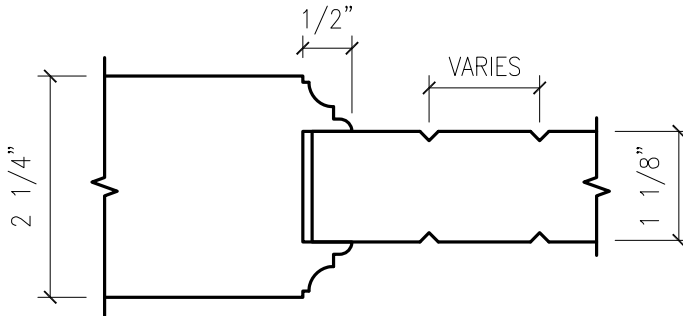

V-GROOVE FLATPANEL
(NOT AVAILABLE WITH 1 3/4" DOOR THICKNESS)

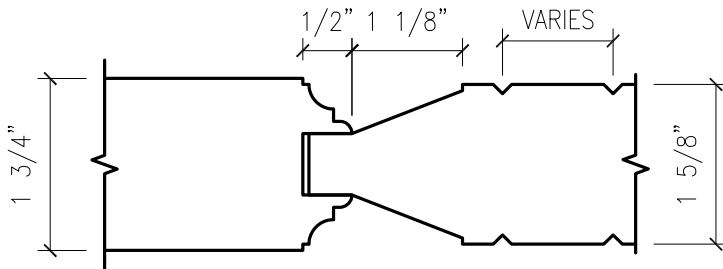

V-GROOVE RAISED PANEL

HARRING DOORS HAS A LARGE LIBRARY OF CUSTOM TOOLING AVAILABLE. THESE DRAWINGS ILLUSTRATE OUR MOST COMMON PROFILES. WE CAN ALSO SOURCE CUSTOM TOOLING TO ACCOMMODATE YOUR CUSTOM DOOR REQUIREMENTS. CONTACT OUR SALES DEPARTMENT WITH ANY CUSTOM REQUESTS

STANDARD NO PROFILE WITH STANDARD PANELS

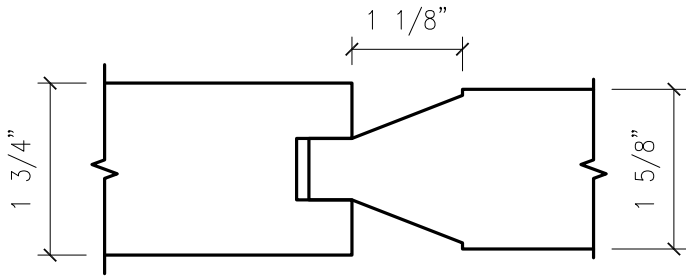

PANEL A1
(RIM BANDED)

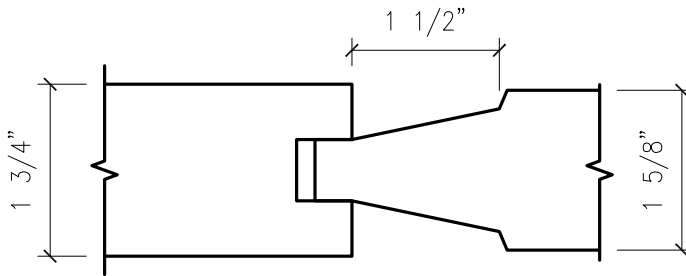

PANEL 3
(RIM BANDED)

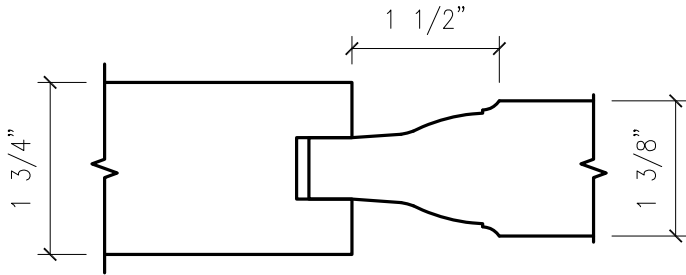

PANEL R1
(RIM BANDED)

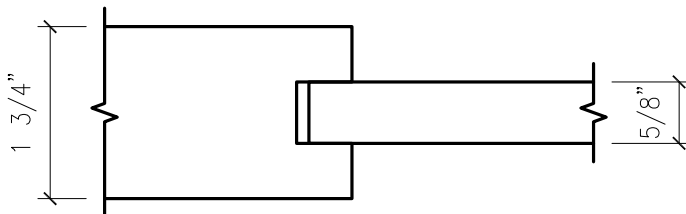

FLAT PANEL

HARRING DOORS HAS A LARGE LIBRARY OF CUSTOM TOOLING AVAILABLE. THESE DRAWINGS ILLUSTRATE OUR MOST COMMON PROFILES. WE CAN ALSO SOURCE CUSTOM TOOLING TO ACCOMMODATE YOUR CUSTOM DOOR REQUIREMENTS. CONTACT OUR SALES DEPARTMENT WITH ANY CUSTOM REQUESTS

STANDARD NO PROFILE WITH STANDARD PANELS

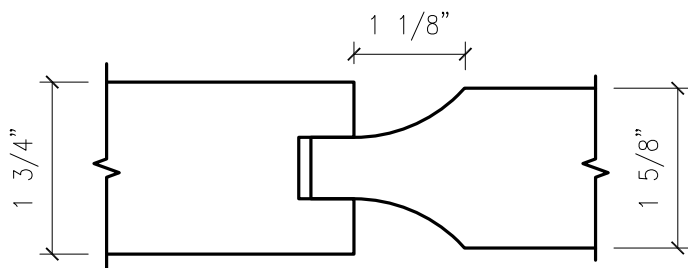

PANEL 2
(RIM BANDED OR
FORMED VENEER)

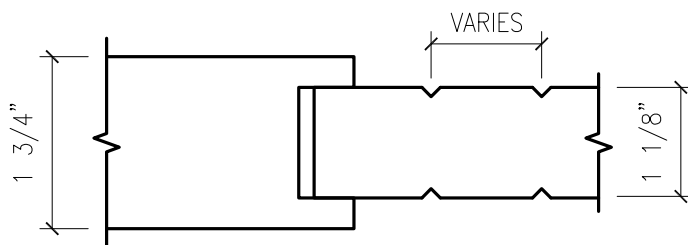

V-GROOVE FLATPANEL

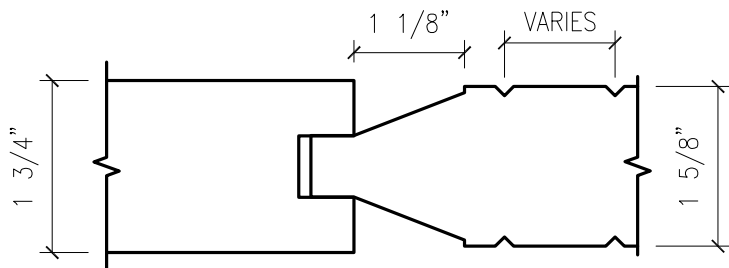

V-GROOVE RAISED PANEL

HARRING DOORS HAS A LARGE LIBRARY OF CUSTOM TOOLING AVAILABLE. THESE DRAWINGS ILLUSTRATE OUR MOST COMMON PROFILES. WE CAN ALSO SOURCE CUSTOM TOOLING TO ACCOMMODATE YOUR CUSTOM DOOR REQUIREMENTS. CONTACT OUR SALES DEPARTMENT WITH ANY CUSTOM REQUESTS

STANDARD OGEE PROFILE WITH STANDARD PANELS

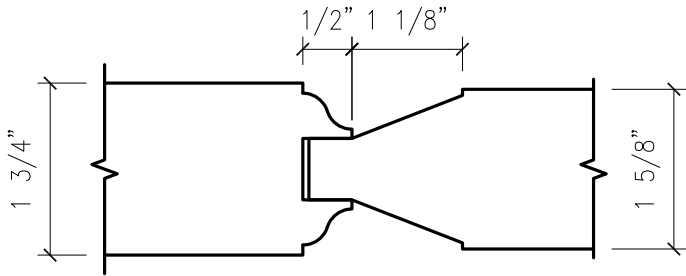

PANEL A1
(RIM BANDED)

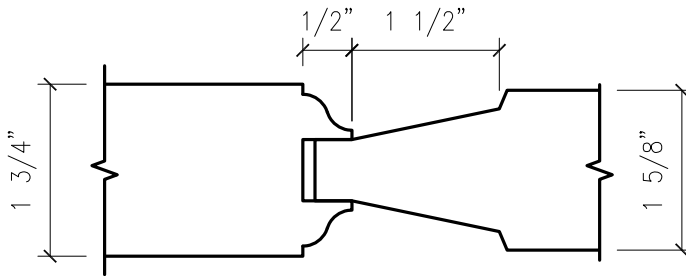

PANEL 3
(RIM BANDED)

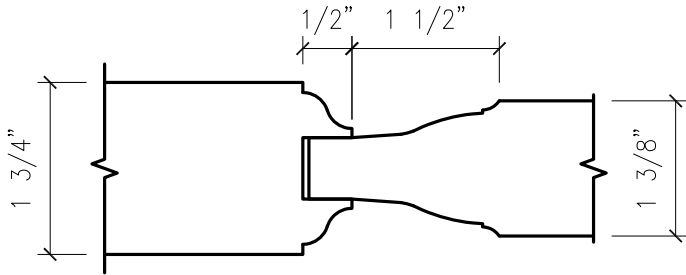

PANEL R1
(RIM BANDED)

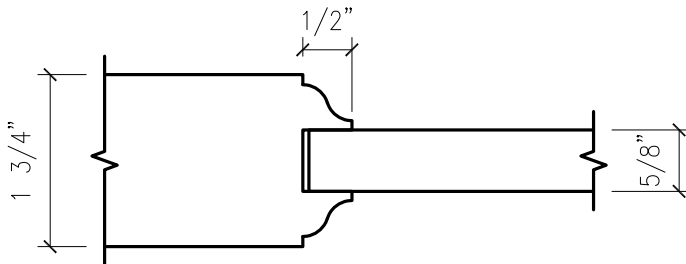

FLAT PANEL

HARRING DOORS HAS A LARGE LIBRARY OF CUSTOM TOOLING AVAILABLE. THESE DRAWINGS ILLUSTRATE OUR MOST COMMON PROFILES. WE CAN ALSO SOURCE CUSTOM TOOLING TO ACCOMMODATE YOUR CUSTOM DOOR REQUIREMENTS. CONTACT OUR SALES DEPARTMENT WITH ANY CUSTOM REQUESTS

STANDARD OGEE PROFILE WITH STANDARD PANELS

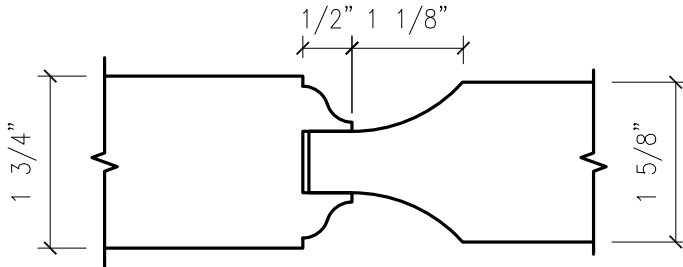

PANEL 2
(RIM BANDED OR
FORMED VENEER)

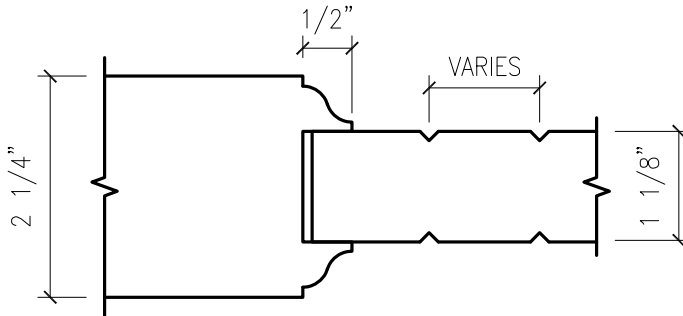

V-GROOVE FLATPANEL
(NOT AVAILABLE WITH 1 3/4" DOOR THICKNESS)

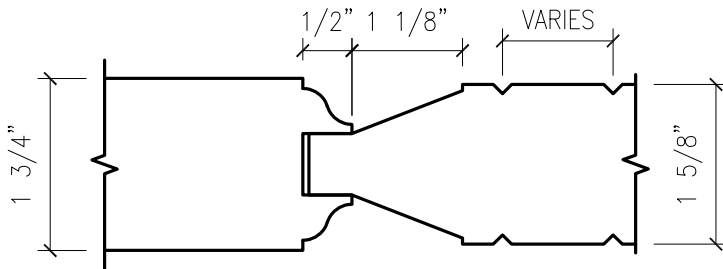

V-GROOVE RAISED PANEL

HARRING DOORS HAS A LARGE LIBRARY OF CUSTOM TOOLING AVAILABLE. THESE DRAWINGS ILLUSTRATE OUR MOST COMMON PROFILES. WE CAN ALSO SOURCE CUSTOM TOOLING TO ACCOMMODATE YOUR CUSTOM DOOR REQUIREMENTS. CONTACT OUR SALES DEPARTMENT WITH ANY CUSTOM REQUESTS

STANDARD SQUARE PROFILE WITH STANDARD PANELS

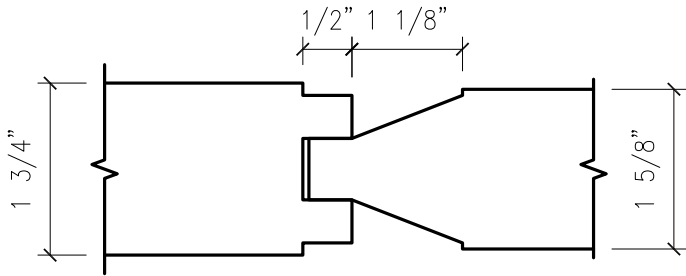

PANEL A1
(RIM BANDED)

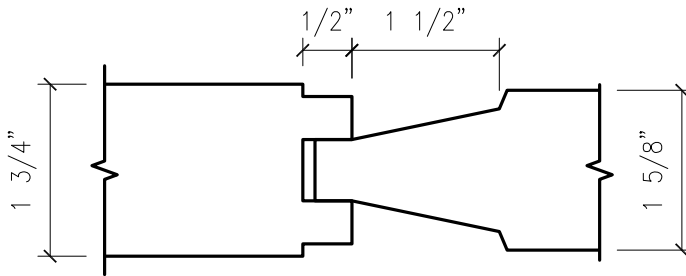

PANEL 3
(RIM BANDED)

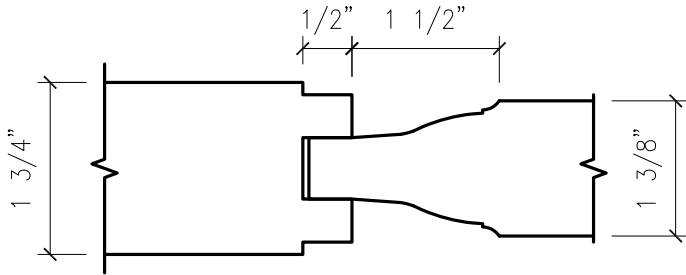

PANEL R1
(RIM BANDED)

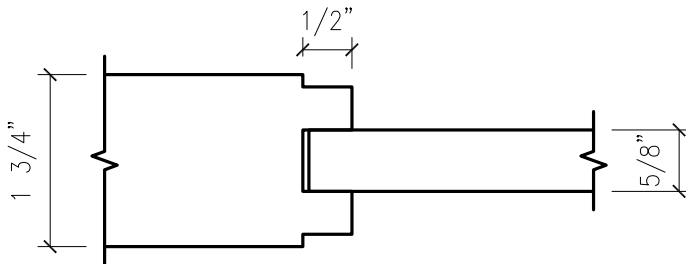

FLAT PANEL

HARRING DOORS HAS A LARGE LIBRARY OF CUSTOM TOOLING AVAILABLE. THESE DRAWINGS ILLUSTRATE OUR MOST COMMON PROFILES. WE CAN ALSO SOURCE CUSTOM TOOLING TO ACCOMMODATE YOUR CUSTOM DOOR REQUIREMENTS. CONTACT OUR SALES DEPARTMENT WITH ANY CUSTOM REQUESTS

STANDARD SQUARE PROFILE WITH STANDARD PANELS

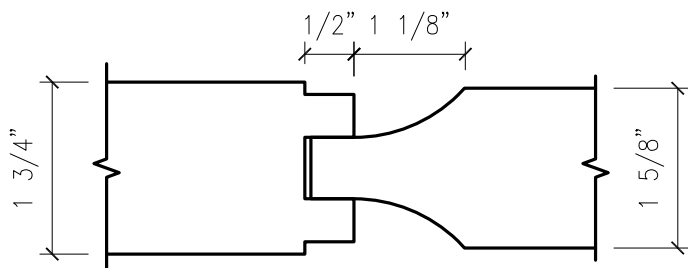

PANEL 2
(RIM BANDED OR
FORMED VENEER)

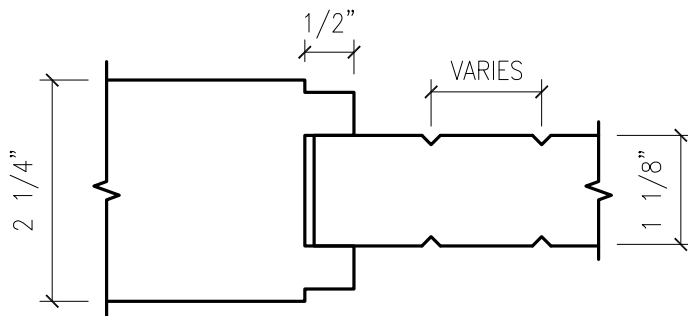

V-GROOVE FLATPANEL
(NOT AVAILABLE WITH 1 3/4"
DOOR THICKNESS)

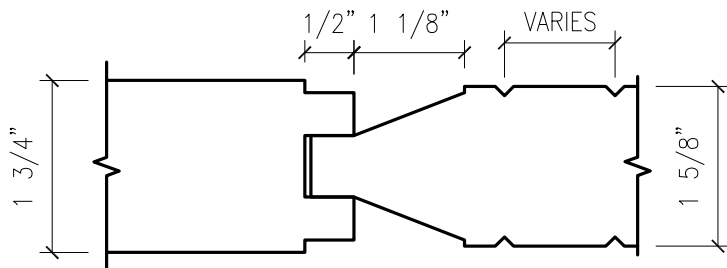

V-GROOVE RAISED PANEL

HARRING DOORS HAS A LARGE LIBRARY OF CUSTOM TOOLING AVAILABLE. THESE DRAWINGS ILLUSTRATE OUR MOST COMMON PROFILES. WE CAN ALSO SOURCE CUSTOM TOOLING TO ACCOMMODATE YOUR CUSTOM DOOR REQUIREMENTS. CONTACT OUR SALES DEPARTMENT WITH ANY CUSTOM REQUESTS

TRUE DIVIDED LITE(TDL) & SIMULATED DIVIDED LITE(SDL)

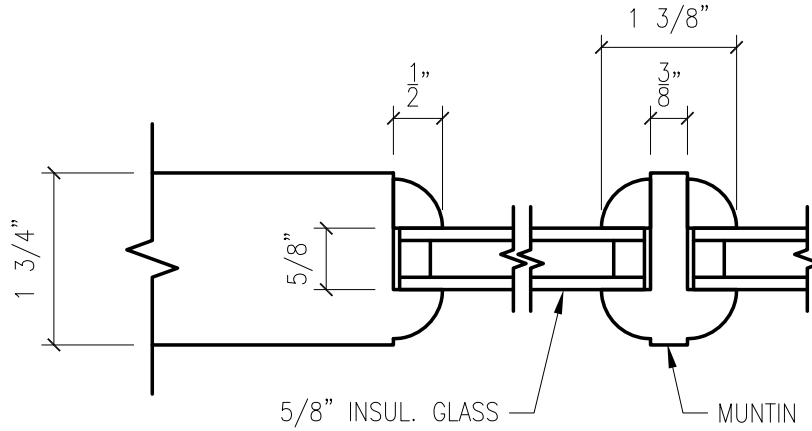

STANDARD TRUE DIVIDED LITE (TDL)

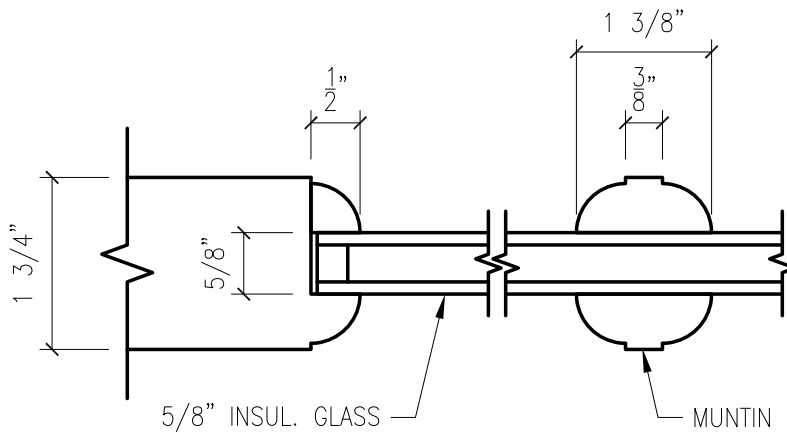

STANDARD SIMULATED DIVIDED LITE (SDL)

NOTE: STICKING PROFILE & GLAZING OPTIONS VARY BASED ON SELECTION AND AVAILABLE TOOLING